

## RESEARCH ON SOLAR ADSORPTION COOLING SYSTEM

Robert SEKRET <sup>a\*</sup>, Michał TURSKI <sup>b</sup>

<sup>a</sup>Prof.; Faculty of Environmental Protection and Engineering, Czestochowa University of Technology,  
60A Brzeznicka St., 42-200 Czestochowa, Poland  
E-mail address: [rsekret@is.pcz.czest.pl](mailto:rsekret@is.pcz.czest.pl)

<sup>b</sup>MSc; Faculty of Environmental Protection and Engineering, Czestochowa University of Technology,  
60A Brzeznicka St., 42-200 Czestochowa, Poland

Received: 09.02.2012; Revised: 14.04.2012; Accepted: 18.04.2012

### Abstract

In the current paper research on possibilities for ensuring a thermal comfort through usage of an adsorption cooling system supplied by solar energy has been presented. The main thesis was to ensure an adequate level of coldness in a referential room of a 30 m<sup>3</sup> cubature. The coldness was generated by an adsorption ice water generator, supplied by energy coming from flat-plate solar collectors. Experiments on AIWG work conditions and an analysis of possibilities of usage of solar energy in a region of Czestochowa (Poland) for supplying the adsorption cooling system have also been presented. A real value of a cooling efficiency of a COP coefficient for the adsorption ice water generator was 0.27, and a real global efficiency of the adsorption cooling system was 0.23. On the basis of received results it was assumed that in a climate conditions typical for Poland it is possible to effectively use the adsorption cooling system in order to keep a constant level of the thermal comfort during all months in which there is a demand for coldness, i.e. between April and October.

### Streszczenie

W artykule przedstawiono badania możliwości zapewnienia komfortu cieplnego poprzez zastosowanie adsorpcyjnego systemu chłodzenia zasilanego energią promieniowania słonecznego. Głównym założeniem było zapewnienie pokrycia zapotrzebowania na chłód dla pomieszczenia referencyjnego o kubaturze 30 m<sup>3</sup>. Chłód był wytwarzany przez adsorpcyjną wytwornicę wody lodowej, zasilaną energią z płaskich kolektorów słonecznych. Przedstawiono również badania eksperymentalne warunków pracy AWWL oraz dokonano analizy możliwości wykorzystania energii promieniowania słonecznego na terenie Częstochowy (Polska) do zasilania adsorpcyjnego systemu chłodzenia. Rzeczywista wartość współczynnika wydajności chłodniczej COP adsorpcyjnej wytwornicy wody lodowej wyniosła 0.27, a rzeczywista całkowita sprawność adsorpcyjnego systemu chłodzenia wyniosła 0.23. Na podstawie uzyskanych wyników badań stwierdzono, że w warunkach klimatycznych Polski można efektywnie wykorzystać adsorpcyjny system chłodzenia w celu utrzymania warunków komfortu cieplnego we wszystkich miesiącach, w których występuje zapotrzebowanie na chłód, tj. od kwietnia do października.

Keywords: Solar cooling; Adsorption chiller; Adsorption ice water generator; Thermal comfort.

## 1. INTRODUCTION

An increase of efficiency in energy use as well as an integration of heating and cooling systems with a higher contribution of renewable sources of energy are considered to be among key elements of development of new technologies for covering energy needs of municipal and household sectors and public utility buildings, as it has been pointed out in theses [1,2,3,4].

Continuous effort to reduce a level of energy-consumption, and at the same time a leak-proofness of buildings, is strictly connected with an increasing demand for its cooling at summer time. It is caused by a necessity of delivering fresh air in order to reduce a level of CO<sub>2</sub> concentration and lowering a level of inner temperature and humidity to a permissible level inside buildings, as it is determined with quality norms for the inner environment. Currently used refrigerat-

ing compressors are supplied by electric energy, so they are using a primary source of energy. And therefore lowering demands for energy for heating purposes at winter time causes an increase of demand for the primary energy for ventilation and air-conditioning at summer time. In order to avoid the increase of the demand for the primary energy in summer months some renewable energy sources or waste heat might be used for supplying refrigerating systems. Such possibilities are given by refrigerating machines supplied with solar energy. Their maximum cooling power is received at a highest level of solar radiation, and that means at a time when the highest demand for coldness is observed.

## 2. DEVELOPMENT DIRECTIONS

A still dominating technology at the European market of solar refrigerating installations are absorption chillers, however, some new development trends currently observed are directed towards reducing their usage. A reason for such situation is a possibility of taking advantage of alternative systems, both adsorption and open ones, with parameters of a heating medium below the level of 90°C. In Polish climate conditions the demand for coldness is observed between April and October. Simultaneously received values of the heating medium – by means of commonly used solar collectors – are between 60÷95°C, however, most of the time the value of the heating medium obtained is at a level of 80°C.

Among all available cooling systems supplied with solar energy, the adsorption refrigerating systems have been recognized as the most advantageous for cooling rooms in Polish climate conditions. They use renewable sources of energy in the same way as other systems; however, when one takes into consideration the lowest parameters of operation, only open systems are competitive with the adsorption systems. When the temperature of the heating medium is between 60÷95°C the adsorption chillers obtain a coefficient of cooling efficiency at the level of 0.6÷0.7. With a solid sorbent the coefficient of cooling efficiency (COP) in open systems is 0.6÷1.0 (with temperature of the supplying factor between 45÷95°C), whereas with a liquid sorbent the COP is about 1.0 (with the value of temperature of the heating medium between 60÷80°C). However, the open systems, working at an aerial set, become specially ineffective when heat gains are significant and when it is necessary to derivate them from a building by increasing a number of air circulations in a room. An

essential defect of the open systems is a reduced possibility of using them. They may be operated only in such conditions when cooling of the air takes place at a central unit of air-conditioning and when a process of air treatment depends on its cooling. An additional constrain is lack of possibility to achieve a low level of temperature of the air supply. With the value of the computational temperature of external air at summer time, equal to 30°C, a minimum temperature of the supply air which could be obtained is 18°C. All those factors have negative impact on receiving desired levels of the air supply. And therefore the adsorption refrigerating systems supplied with solar energy seem to be the most promising solution to the problem.

Constructing and using the adsorption refrigerating systems of low power, supplied by solar energy is still an unknown issue in Poland. Any official guidelines for constructing a low power adsorption ice water generator (AIWG) for Polish climate conditions has not been worked out yet. A deeper analysis of possible usage of the low power AIWG for obtaining the thermal comfort in rooms, relevant to external atmospheric conditions, has not been conducted either. After a critical analysis of available literature as well as own scientific experiments a model low power AIWG and a cooling system supplied with solar energy for lowering the temperature in buildings to the level of obtaining the thermal comfort in rooms, have been constructed.

## 3. DESCRIPTION OF A TEST STAND

The test stand comprised four basic modules: a generation module, an accumulation module, a transmission module and an energy usage module. A diagram of the test stand, with a description and location of the measurement devices, has been presented in Figure 1. Basic devices and their descriptions have been shown below:

1 – solar collectors, 2 – Solarpol-Artur1 module, 3 – hot water accumulator, 4 – AIWG,

5 – computer with a measurement card, 6 – ventilation central point

Measurement points:

**a** – temperature sensor of the collectors' working medium, **b** – water temperature sensor in the accumulator, **c** – temperature sensor of a working medium going into the collectors and a working medium going out of a flow pipeline, **d** – temperature sensor of a working medium going out of the collectors and

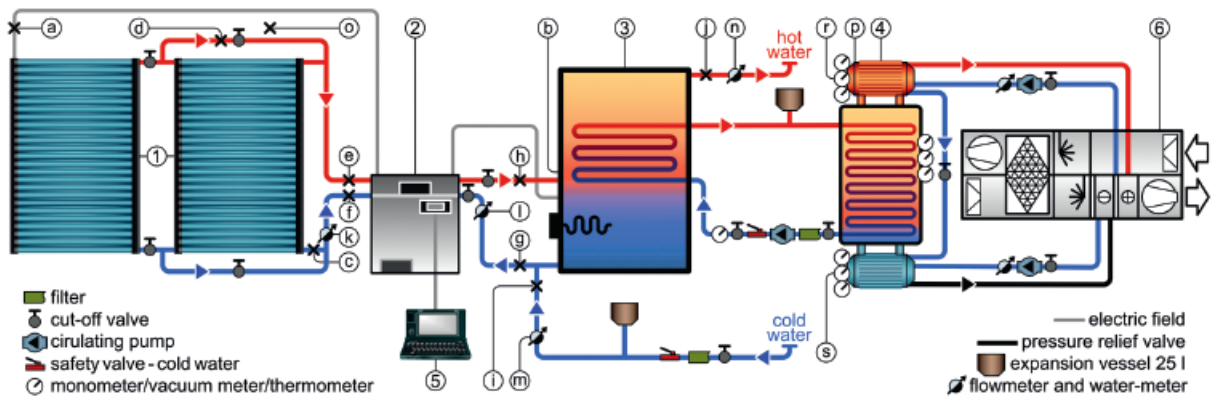

**Figure 1.**  
Diagram of the adsorption cooling system supplied with solar energy

a working medium going into a return pipeline, e – temperature sensor of a working medium going out of the return pipeline and of a working medium going into a heat exchanger of the Solarpol module, f – temperature sensor of a working medium going into a supplying pipeline and of a working medium going out of the heat exchanger of the Solarpol module, g – temperature sensor of cool water going into the heat exchanger of Solarpol module from the accumulator, h – temperature sensor of warm water going into the accumulator from the heat exchanger of the Solarpol module, i – temperature sensor of cool pipe water going into the collector, j – temperature sensor of warm water received from the collector, k – flowmeter for measuring a flow of a working medium inside the pipe supplying the solar collectors, l – flowmeter for measuring a flow of cool water from the collector to the heat exchanger of the Solarpol module, m – flowmeter for measuring a flow of cool pipe water supplying the collector, n – water meter for measuring a volume of absorbed water, o – temperature sensor for outside conditions (atmospheric air), p – manometer and vacuum meter of a condenser, r – manometer and vacuum meter of an adsorber, s – manometer and vacuum meter of an evaporator.

#### 4. RESEARCH METHODOLOGY

Experimental research included three separate phases. The first phase was devoted to determination of possible to obtain, with the use of solar collectors, temperatures of water supplying AIWG. The target was achieved through analyses of meteorological data received from the database of the Infrastructure

Ministry [5], collected within a period of 30-year long measurements, on the basis of which typical meteorological years were defined for particular stations. Comparing then the theoretical data with results achieved from measurements carried out in real conditions with the use of described above installation and registered by the measuring system, conditions for operation of the adsorption cooling system were obtained.

The second phase of the research consisted of an investigation of the adsorption cooling process and determination of conceptual characteristics of AIWG operation in conditions corresponding to *c* temperatures of the heating medium. During this phase, for the purposes of the experiment, simulated possible values of temperatures of the heating medium obtained through the use of the solar collectors were 60°C, 80°C and 95°C. Also initial temperatures of the working medium were differentiated, and their values were: 20°C, 16°C and 12°C, respectively. Assuming that the time of adsorption (cooling) is equal to the time of desorption, the measurements were conducted for the following periods within the course of the whole process: 15/15 min, 30/30 min and 60/60 min. Because of complex operational parameters of AIWG, 27 measurements were accomplished, i.e. three repetitions during each measurement. Reading data from the measurement devices took place every single minute. During the third phase an analysis of possible applications of AIWG for obtaining the thermal comfort in a referential room, in relation to changing weather conditions, was carried out. On the basis of the results achieved during the two previous phases of the investigations, i.e. the analysis of the real potential of solar radiation and the characteristics of AIWG operation in chang-

ing conditions, parameters and relations connected to the process of air cooling into the referential room were determined. They included: demand for cooling power, amount of useful heat received from the solar radiation energy, excess of thermal power, cooling power and its excess in a function of time, distribution of inner temperature with and without the cooling system, and also intensity of solar radiation in a function of time.

### 5. ANALYSIS OF THE RESULTS

On the basis of the carried out analysis of the obtained experimental results the following dependences for AIWG were determined: distribution of temperature and pressure in a function of time, distribution of cooling power in a function of time of the heating medium and initial temperature in the evaporator. Additionally such parameters were determined as: real cooling power, real demand for AIWG thermal power and its refrigerating efficiency coefficient. In Figures 2-5 examples of the conducted investigations have been presented.

Possibilities of using the intensity of the solar radiation in the city of Czestochowa for fulfilling needs of coldness for the referential room through using AIWG were also investigated. Parameters which were used to determine functionality of the system in certain real conditions were: excess of the thermal power, excess of the cooling power and cooling power itself. In Figure 6 examples of the conducted investigations have been presented.

Finally an impact of the adsorption cooling system using the solar radiation energy for ensuring the ther-

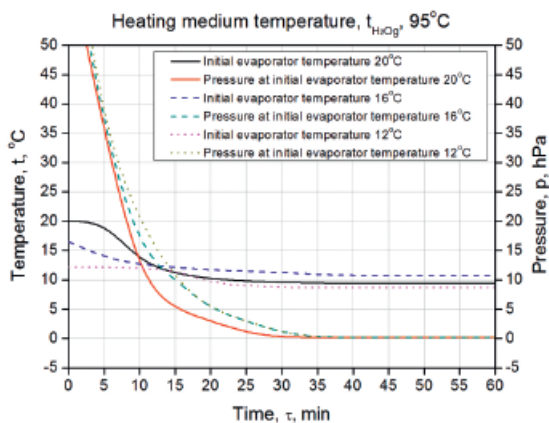

Figure 2. Distribution of temperature and pressure in the evaporator of AIWG in a function of time. Measurement carried out with the temperature of the heating medium equal to 95°C

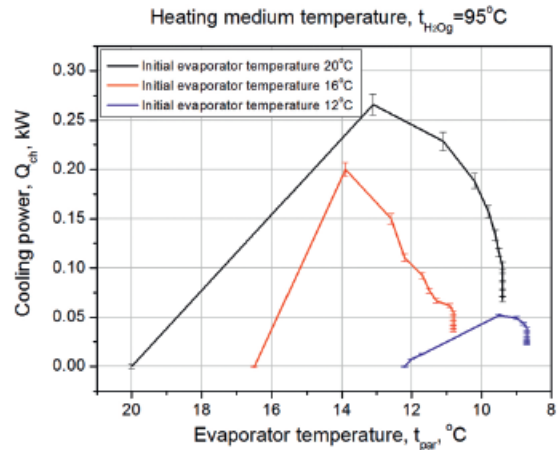

Figure 3. Dependence of the AIWG cooling power from the temperature of the heating medium and the initial temperature in the evaporator. Measurement carried out with the temperature of the heating medium equal to 95°C

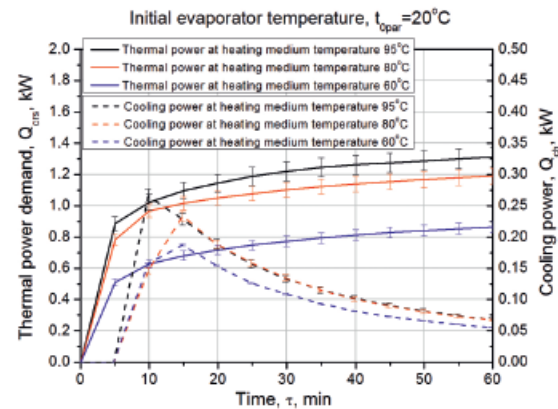

Figure 4. Dependence of the AIWG cooling power and demand for the thermal power in a function of time. Measurements carried out with the initial temperature of the working medium equal to 20°C

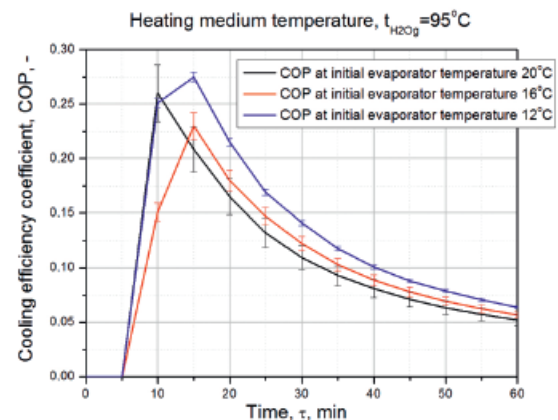
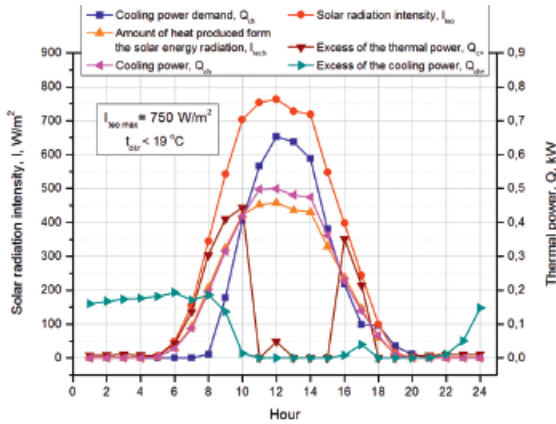
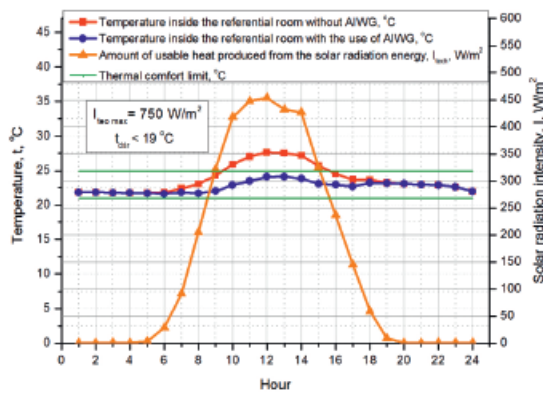

Figure 5. Dependence of the AIWG's refrigerating efficiency coefficient from the time. Measurements carried out with the temperature of the heating medium equal to 95°C

mal comfort in the referential room has been investigated. To complete the scientific research advantage was taken of the results coming from the analyses of the dependence of the internal temperature in the referential room from the external temperature in a function of time. In Figure 7 examples of the conducted investigations have been presented.



**Figure 6.** Real operational parameters of the adsorption cooling system for the referential room for the maximum value of the solar radiation intensity 750 W/m<sup>2</sup>; an average 24-hour external temperature below 19°C



**Figure 7.** Distribution of the internal temperature for the referential room with the maximum value of the solar radiation intensity equal to 750 W/m<sup>2</sup>; an average 24-hour external temperature below 19°C

## 6. SUMMARY

Having conducted the AIWG research in the real conditions, i.e. in the temperature conditions of the heating medium possible to obtain through the use of the solar collectors: 60°C, 80°C and 95°C, and the initial temperatures of the working medium equal to 20°C, 16°C and 12°C, respectively, it may be concluded that:

1. AIWG operates more effectively with parameters close to its maximal power, i.e. with the temperature of the heating medium between 80÷95°C.
2. Higher levels of cooling power of AIWG were obtained with an increase of the regeneration process temperatures and with an increase of the initial temperature of the working medium. A list of cooling power values received during the experimental investigations has been shown in Table 1.

**Table 1.** Received values of the AIWG cooling power in function of the sorbent regeneration temperature and the initial temperature of the working medium

	Heating medium temperature, t <sub>H2Og</sub> , °C			
	95	80	60	
Initial working medium temperature, t <sub>H2Og</sub> , °C	20	0.27	0.23	0.18
	16	0.20	0.16	0.12
	12	0.05	0.04	0.02

3. The initial temperature of the working medium has a more significant impact on the cooling power than the heating medium temperature values (within the investigated range). It is therefore necessary to ensure in the cooling system an ice water stream of a strictly determined value of temperature, relevant to a project's purposes.
4. An optimum time of cooling was between 10 and 15 minutes, depending on a preceding values of temperatures of sorbent bed regeneration. For the regeneration temperature equal to 95°C and 60°C, the optimum time of cooling was 10 min and 15 min, respectively.
5. With a higher level of the initial temperature of the working medium the received cooling efficiency was higher. A list of the values of the received AIWG cooling efficiency coefficient has been presented in Table 2.

**Table 2.**  
The received values of the COP AIWG cooling efficiency coefficient in a function of the sorbent regeneration temperature and the initial temperature of the working medium

Initial working medium temperature, $t_{H_2Og}$ , °C	Heating medium temperature, $t_{H_2Og}$ , °C		
	95	80	60
20	0.27	0.23	0.05
16	0.23	0.25	0.05
12	0.27	0.24	0.04

After accomplishing the analysis of the results referring to the possibilities of covering demand for coldness in the referential room by AIWG in strictly determined ranges of solar radiation intensity it may be concluded:

1. The cooling power of 100 W was enough for covering the need for coldness with the maximum intensity of the solar radiation equal to 200 W/m<sup>2</sup>, but only with the use of an additional source of heat during the process of regeneration.
2. When values of the solar radiation were in the range between 500 ÷ 900 W/m<sup>2</sup>, i.e. for April, May, September, and October: 750 W/m<sup>2</sup>, 900 W/m<sup>2</sup>, 600 W/m<sup>2</sup> and 500 W/m<sup>2</sup>, respectively, the demand for coldness was significantly covered by the cooling system itself. In hours of the highest level of the solar radiation (from 10<sup>am</sup> to 3<sup>pm</sup>) the demand for coldness was higher than the operational capacity of AIWG could provide. Within these hours an increase of the internal temperature was still in the range of admissible thermal comfort.
3. When values of the solar radiation were in the range of 900 ÷ 1200 W/m<sup>2</sup>, i.e. for June and July-August: 1200 W/m<sup>2</sup> and 900 W/m<sup>2</sup>, respectively, the demand for coldness was not fully covered by the cooling system because of too low refrigerating power of AIWG. Additionally, the deficiency of the coldness was not compensated by delivering to the AIWG supplying system any excess of stored heat.

On the basis of the analysis of the investigations devoted to determination of the impact of the adsorption cooling system on the thermal comfort in the referential room, the following was concluded:

1. On a day with low intensity of the solar radiation 200 W/m<sup>2</sup> the use of AIWG ensured temperatures inside the referential room in the range adequate for the thermal comfort.
2. When the solar radiation intensity was in the range between 500 ÷ 900 W/m<sup>2</sup> (adequate to average

radiations in months of April, May, September and October: 750 W/m<sup>2</sup>, 900 W/m<sup>2</sup>, 600 W/m<sup>2</sup> and 500 W/m<sup>2</sup>, respectively), the investigated system of the adsorption cooling ensured temperatures inside the referential room still in the range admissible for the thermal comfort, i.e. between 21.6 ÷ 25.4°C.

3. When the solar radiation intensity was in the range between 900 ÷ 1200 W/m<sup>2</sup> (adequate to average radiations in months of June and July-August: 1200 W/m<sup>2</sup> and 900 W/m<sup>2</sup>, respectively), the adsorption cooling system could not guarantee the inner temperature in the referential room at the level corresponding to the range of the thermal comfort. During these months the values of the temperatures inside the referential room were between 21.7 ÷ 27.8°C. The increase of the temperature above the permissible level of the thermal comfort was caused by too low cooling power of AIWG for the solar radiation intensity located in the range between 900 ÷ 1200 W/m<sup>2</sup>.

## 7. CONCLUSIONS

The adsorption cooling systems supplied with the solar radiation energy remain an open problem which requires further investigations. However, the presented scientific material has helped to formulate some conclusions.

In Polish climate conditions, and with present efficiency of solar collectors, the demand for coldness to ensure the thermal comfort for human beings inside buildings occurs when the value of the heating medium is above 60°C.

It is necessary to remember about additional source of heat during the designing process of an adsorption cooling system. The usage of the additional thermal source is dependent on a minimum value of the solar radiation intensity, whereas a volume of the heat accumulator depends on a maximum value of the solar radiation intensity.

The higher is the intensity of the solar radiation, the higher are the values of cooling power and of the efficiency coefficient of the adsorption generator of ice water.

Lack of coverage of the coldness demand in rooms occurs in extreme conditions of the solar radiation intensity, i.e. for the values of 200 W/m<sup>2</sup> and 1200 W/m<sup>2</sup>, and with simultaneous 24-hour average external air temperature above 19°C. It is necessary to treat such cases only as theoretical ones as they

appear very seldom in real conditions.

It is possible to increase the AIWG cooling efficiency through its compact construction.

An important element influencing the level of thermal comfort in a room is depending the refrigerating time and regeneration on the temperature of the heating medium. The higher is the temperature of the heating medium in the process of regeneration, the shorter is the time of cooling with the same efficiency. Apart from the solar radiation intensity, other important factors which have an impact of the cooling process efficiency are: the average 24-hour external air temperature and the temperature of the ice water stream at an inlet of the evaporator.

Taking into account further development of the adsorption refrigerating systems it is necessary to consider follow-up scientific research in order to improve efficiency of the heat and cool exchangers as well as to introduce automation into a prototype of the installation.

## ACKNOWLEDGEMENT

This scientific research has been financed from the MNiSW (Ministry of Science and Higher Education) resources allocated for scientific development in the years 2010-2012, as Research Promoter's Project No. N N523 611039.

## REFERENCES

- [1] *Besler G.J., Besler M.*; Mikroklimat pomieszczeń – prognozy rozwoju i kierunki badań (Microclimate of rooms – forecasts of the development and lines of research). Ciepłownictwo, Ogrzewnictwo, Wentylacja, Vol.2, 2008
- [2] Directive 2010/31/UE of the European Parliament and Council dated 19<sup>th</sup> May 2010 on energy characteristics of buildings, 2010
- [3] Directive 2006/32/WE of the European Parliament and Council dated 5 of April 2006 on the effectiveness of final using the energy and energy services, 2006
- [4] The Energy Effectiveness Act dated 15th April 2011; (Dz. U. Nr 94, poz. 551), 2011
- [5] Infrastructure Ministry; Typowe lata meteorologiczne i statystyczne dane klimatyczne dla obszaru Polski do obliczeń energetycznych budynków (Typical meteorological years and statistical climatic data for the area of Poland used for energy calculations of buildings). [www.mi.gov.pl](http://www.mi.gov.pl)